

Features:

- Isolated mounting base 3000V~
- Pressure contact technology with increased power cycling capability
- Space and weight saving

Typical Applications

- AC/DC Motor drives
- Various rectifiers
- DC supply for PWM inverter

V_{RSM}	V_{RRM}	Type & Outline
900V	800V	MDx160-08-216F3
1100V	1000V	MDx160-10-216F3
1300V	1200V	MDx160-12-216F3
1500V	1400V	MDx160-14-216F3
1700V	1600V	MDx160-16-216F3
1900V	1800V	MDx160-18-216F3

SYMBOL	CHARACTERISTIC	TEST CONDITIONS	$T_J(^{\circ}C)$	VALUE			UNIT
				Min	Type	Max	
$I_{F(AV)}$	Mean forward current	180° half sine wave 50Hz Single side cooled, $T_C=100^{\circ}C$	150			160	A
$I_F (RMS)$	RMS forward current		150			251	A
I_{RRM}	Repetitive peak current	at V_{RRM}	150			12	mA
I_{FSM}	Surge forward current	10ms half sine wave	150			4.60	KA
I^2t	I^2T for fusing coordination	$V_R=0.6V_{RRM}$				106	$A^2s \cdot 10^3$
V_{FO}	Threshold voltage		150			0.80	V
r_F	Forward slop resistance					1.35	mΩ
V_{FM}	Peak forward voltage	$I_{FM}=480A$	25			1.56	V
$R_{th(j-c)}$	Thermal resistance Junction to case	At 180° sine Single side cooled per chip				0.230	$^{\circ}C/W$
$R_{th(c-h)}$	Thermal resistance case to heatsink	At 180° sine Single side cooled per chip				0.08	$^{\circ}C/W$
V_{iso}	Isolation voltage	50Hz, R.M.S, $t=1min, I_{iso}: 1mA(max)$		3000			V
F_m	Terminal connection torque(M6)				6		N·m
	Mounting torque(M6)				6		N·m
T_{stg}	Stored temperature			-40		125	$^{\circ}C$
W_t	Weight				285		g
Outline	216F3						

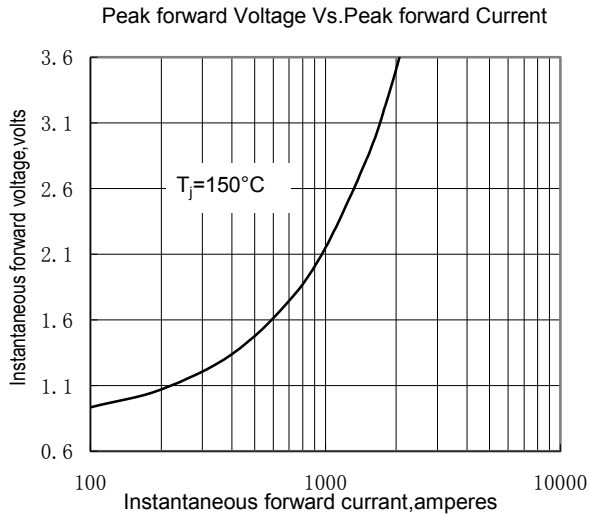

Fig.1

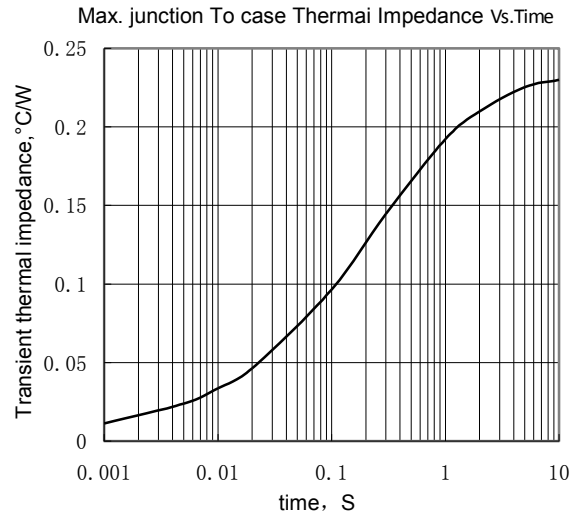

Fig.2

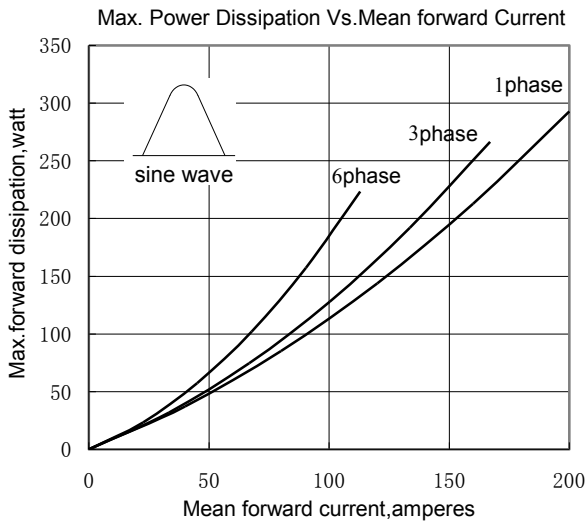

Fig.3

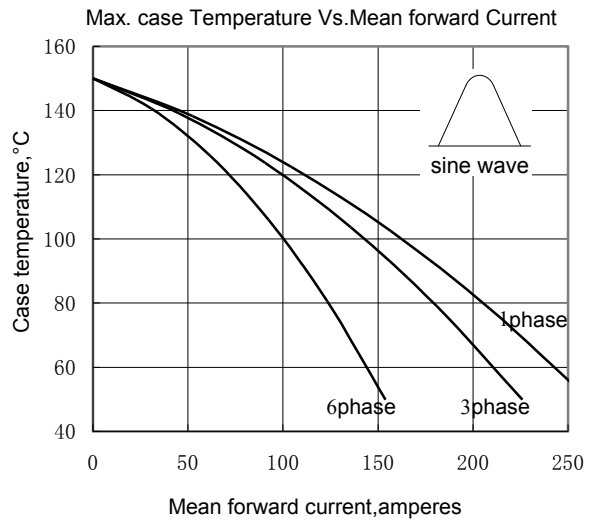

Fig.4

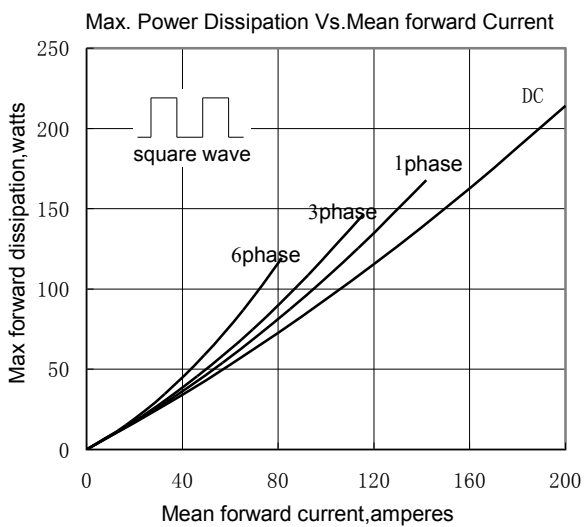

Fig.5

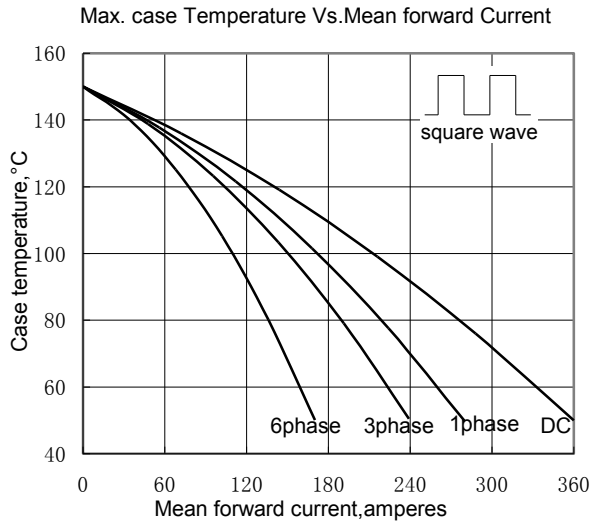

Fig.6

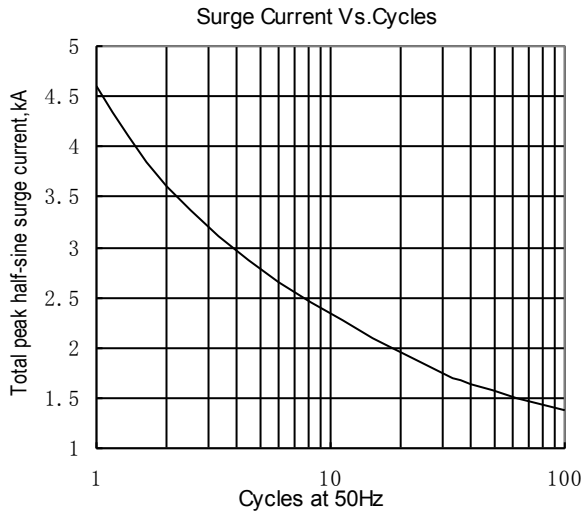

Fig.7

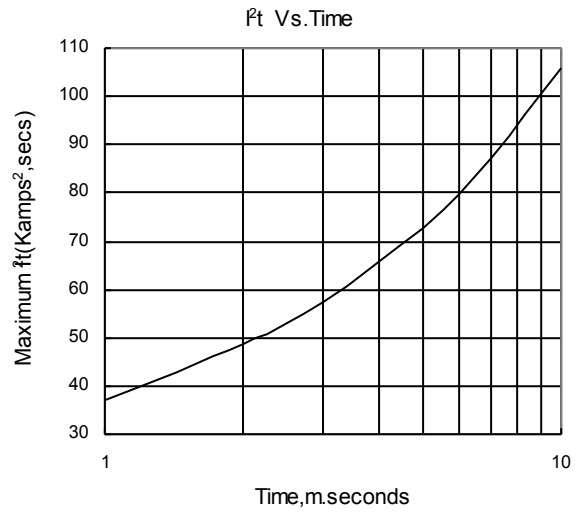
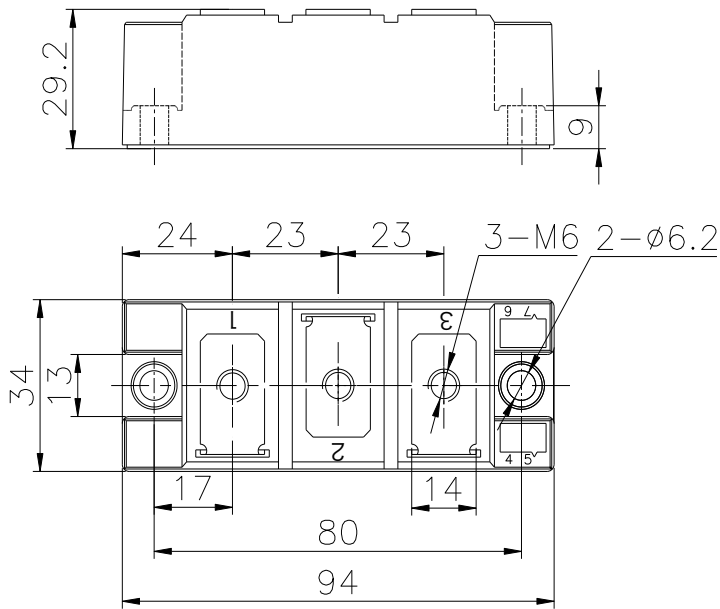

Fig.8

Outline:



216F3

