



Features:

- Isolated mounting base 2500V~
- Pressure contact technology with Increased power cycling capability
- Space and weight savings

Typical Applications

- Inverter
- Inductive heating
- Chopper

V_{RSM}	V_{RRM}	Type & Outline
900 V	800 V	MDS75-08-219H5
1300 V	1200 V	MDS75-12-219H5
1500 V	1400 V	MDS75-14-219H5
1700 V	1600 V	MDS75-16-219H5

SYMBOL	CHARACTERISTIC	TEST CONDITIONS	$T_j(^{\circ}C)$	VALUE			UNIT
				Min	Type	Max	
I_o	DC output current	Three-phase full wave rectifying circuit, $T_C=100^{\circ}C$	150			75	A
I_{RRM}	Repetitive peak current	at V_{RRM}	150			8	mA
I_{FSM}	Surge forward current	10ms half sine wave	100			0.6	KA
I^2t	I^2T for fusing coordination	$V_R=0$				1.8	$A^2s \cdot 10^3$
V_{FO}	Threshold voltage		150			0.7	V
r_F	Forward slop resistance					5.0	$m\Omega$
V_{FM}	Peak forward voltage	$I_{FM}=75A$	25			1.25	V
$R_{th(j-c)}$	Thermal resistance Junction to case	Single side cooled				0.24	$^{\circ}C/W$
$R_{th(c-h)}$	Thermal resistance case to heatsink	Single side cooled				0.07	$^{\circ}C/W$
V_{iso}	Isolation voltage	50Hz,R.M.S,t=1min, $I_{iso}:1mA(max)$		2500			V
F_m	Terminal connection torque(M5)				4		N·m
	Mounting torque(M6)				6		N·m
Tvj	junction temperature			-40		150	$^{\circ}C$
T_{stg}	Stored temperature			-40		125	$^{\circ}C$
W_t	Weight				210		g
Outline	219H5						

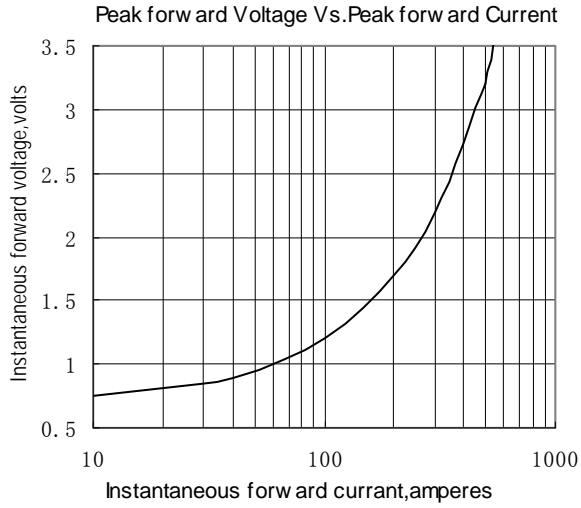

Fig.1

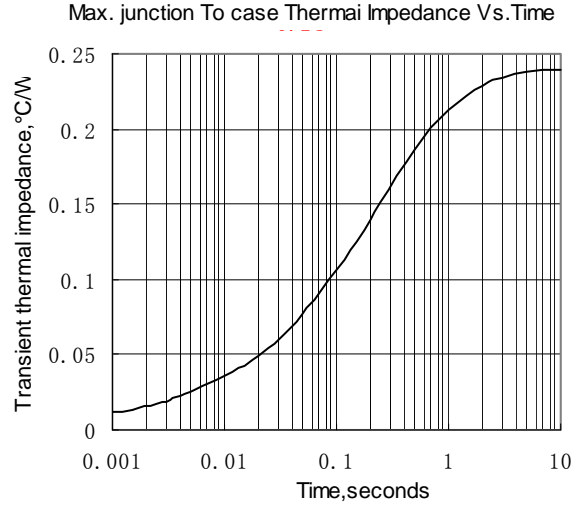

Fig.2

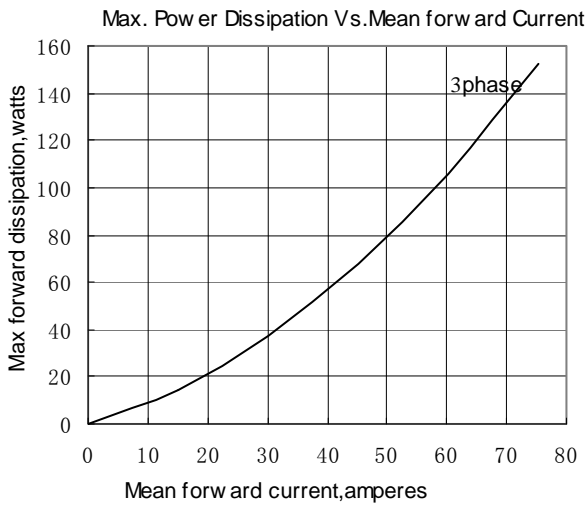

Fig.3

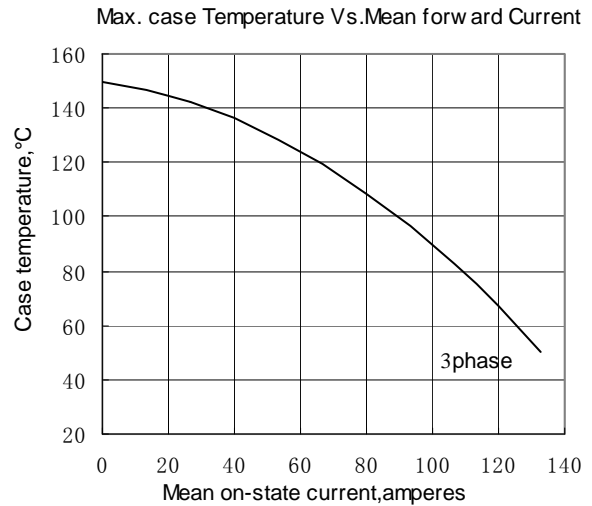

Fig.4

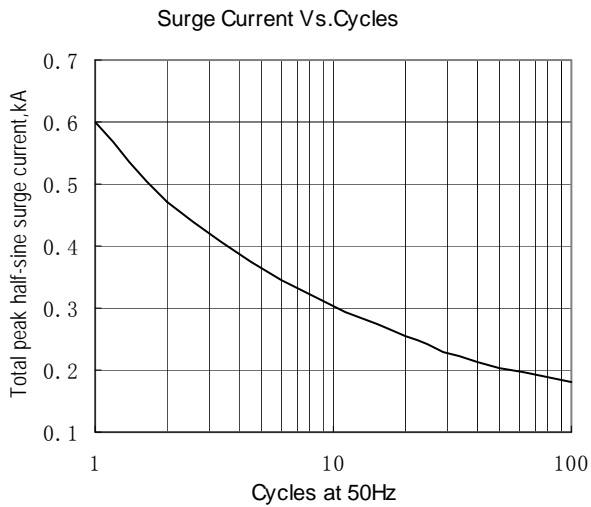

Fig.5

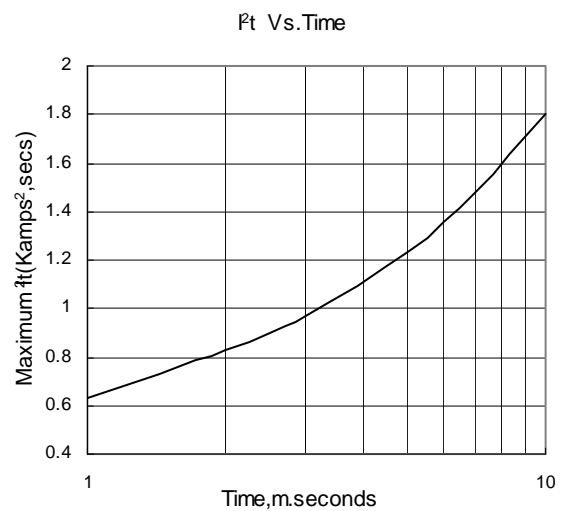
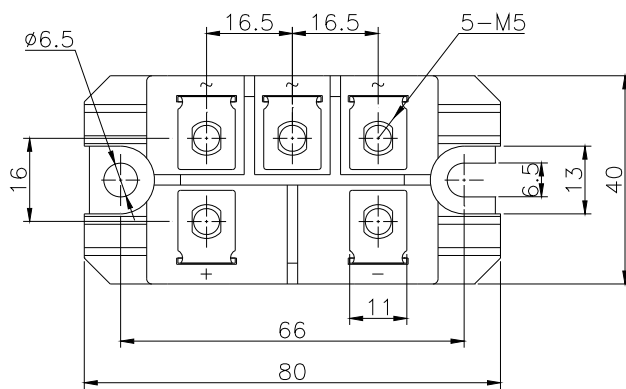
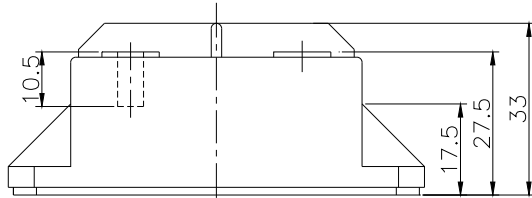

Fig.6

Outline:



219H5

MDS

