



### Features:

- n Isolated mounting base 3000V~
- n Pressure contact technology with Increased power cycling capability

- n Space and weight saving

### Typical Applications

- n AC/DC Motor drives
- n Various rectifiers
- n DC supply for PWM inverter

| $V_{DSM}, V_{RSM}$ | $V_{DRM}, V_{RRM}$ | Type & Outline   |
|--------------------|--------------------|------------------|
| 900V               | 800V               | MTC110-08-223F3B |
| 1100V              | 1000V              | MTC110-10-223F3B |
| 1300V              | 1200V              | MTC110-12-223F3B |
| 1500V              | 1400V              | MTC110-14-223F3B |
| 1700V              | 1600V              | MTC110-16-223F3B |
| 1900V              | 1800V              | MTC110-18-223F3B |

| SYMBOL                 | CHARACTERISTIC                             | TEST CONDITIONS   | $T_f(^{\circ}C)$ | VALUE |      |       | UNIT              |
|------------------------|--|---|------------------|-------|------|-------|-------------------|
|                        |  |   |                  | Min   | Type | Max   |                   |
| $I_{T(AV)}$            | Mean on-state current                      | 180° half sine wave 50Hz<br>Single side cooled, $T_c=85^{\circ}C$ | 125              |       |      | 110   | A                 |
| $I_{T(RMS)}$           | RMS on-state current                       |   | 125              |       |      | 173   | A                 |
| $I_{DRM}$<br>$I_{RRM}$ | Repetitive peak current                    | at $V_{DRM}$<br>at $V_{RRM}$                                      | 125              |       |      | 12    | mA                |
| $I_{TSM}$              | Surge on-state current                     | 10ms half sine wave   | 125              |       |      | 2.20  | KA                |
| $I^2t$                 | $I^2t$ for fusing coordination             | $V_R=60\%V_{RRM}$   |                  |       |      | 24.2  | $A^2s \cdot 10^3$ |
| $V_{TO}$               | Threshold voltage                          |   | 125              |       |      | 0.8   | V                 |
| $r_T$                  | On-state slop resistance                   |   |                  |       |      | 2.29  | mΩ                |
| $V_{TM}$               | Peak on-state voltage                      | $I_{TM}=330A$   | 25               |       |      | 1.69  | V                 |
| $dv/dt$                | Critical rate of rise of off-state voltage | $V_{DM}=67\%V_{DRM}$  | 125              |       |      | 1000  | V/μs              |
| $di/dt$                | Critical rate of rise of on-state current  | Gate source 1.5A<br>$t_r \leq 0.5\mu s$ Repetitive                | 125              |       |      | 200   | A/μs              |
| $I_{GT}$               | Gate trigger current                       | $V_A=12V, I_A=1A$   | 25               | 30    |      | 100   | mA                |
| $V_{GT}$               | Gate trigger voltage                       |   |                  | 1.0   |      | 2.5   | V                 |
| $I_H$                  | Holding current                            |   |                  | 20    |      | 120   | mA                |
| $V_{GD}$               | Non-trigger gate voltage                   | $V_{DM}=67\%V_{DRM}$  | 125              | 0.2   |      |       | V                 |
| $R_{th(j-c)}$          | Thermal resistance<br>Junction to case     | Single side cooled per chip                                       |                  |       |      | 0.250 | $^{\circ}C/W$     |
| $R_{th(c-h)}$          | Thermal resistance<br>case to heatsink     | Single side cooled per chip                                       |                  |       |      | 0.15  | $^{\circ}C/W$     |
| $V_{iso}$              | Isolation voltage                          | 50Hz, R.M.S, $t=1min, I_{iso}:1mA(MAX)$                           |                  | 3000  |      |       | V                 |
| $F_m$                  | Thermal connection torque(M5)              |   |                  |       | 4.0  |       | N·m               |
|                        | Mounting torque(M6)                        |   |                  |       | 6.0  |       | N·m               |
| $T_{stg}$              | Stored temperature                         |   |                  | -40   |      | 125   | $^{\circ}C$       |
| $W_t$                  | Weight                                     |   |                  |       | 160  |       | g                 |
| Outline                | 223F3B                                     |   |                  |       |      |       |                   |

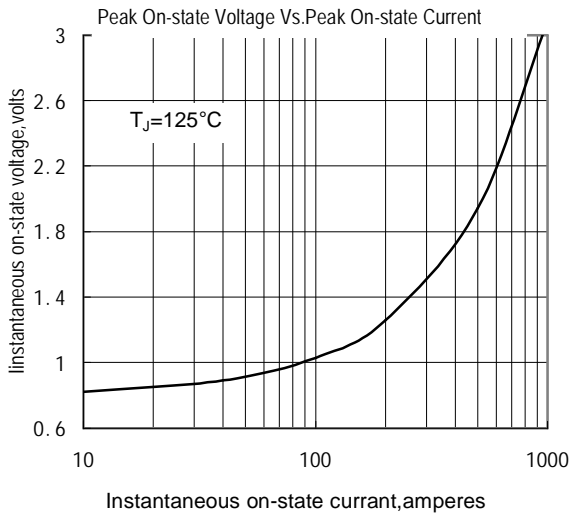

Fig.1

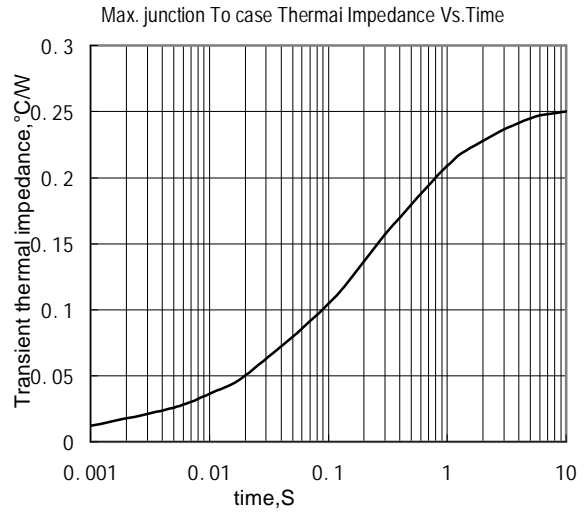

Fig.2

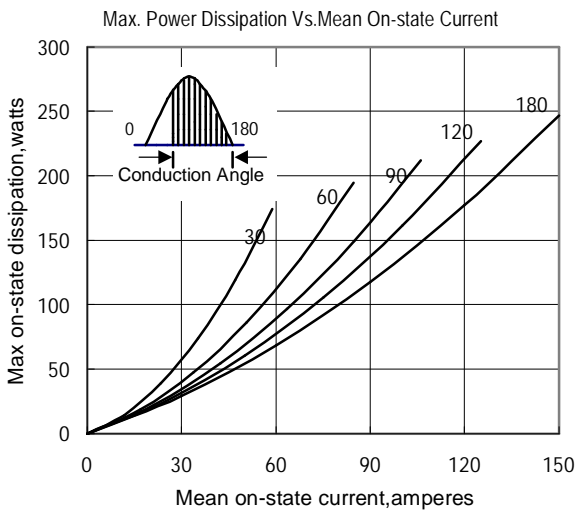

Fig.3

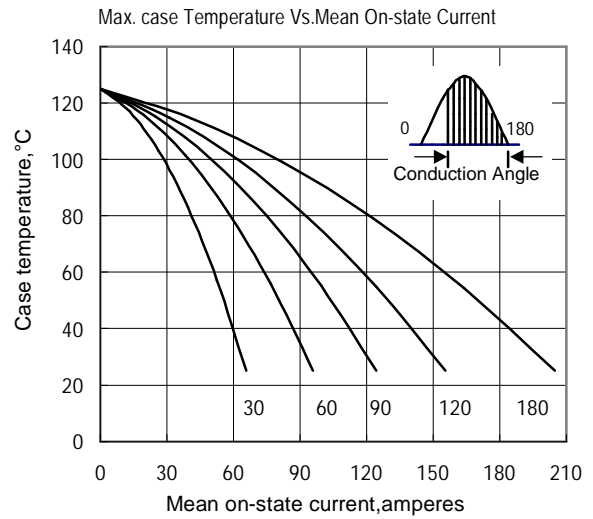

Fig.4

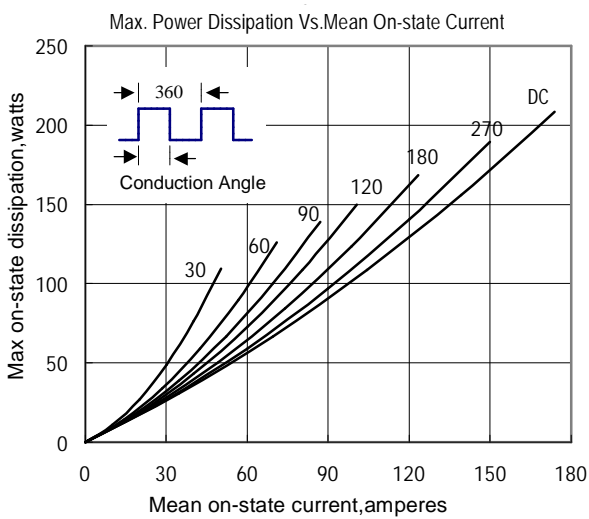

Fig.5

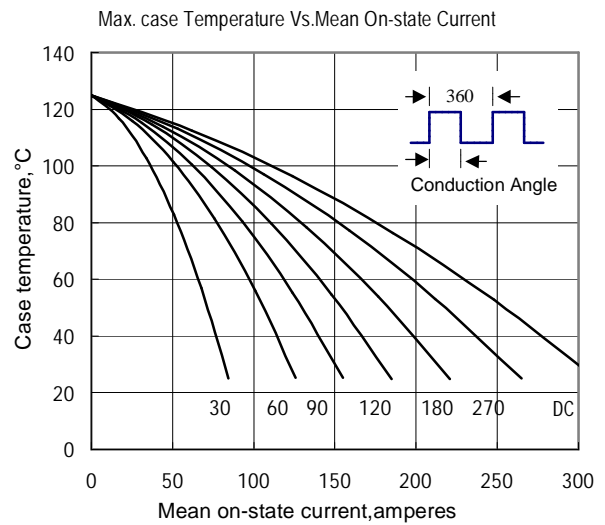

Fig.6

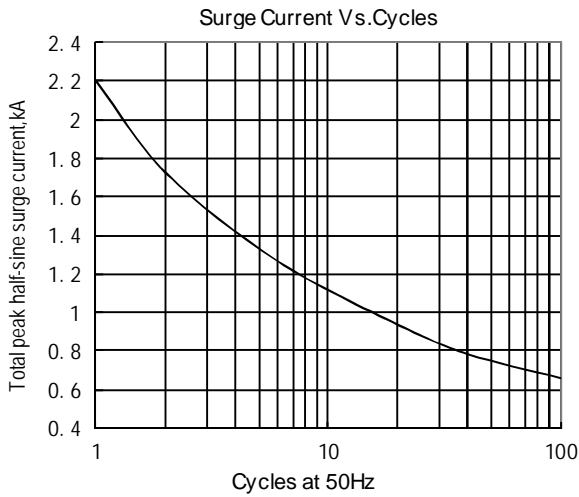

Fig.7

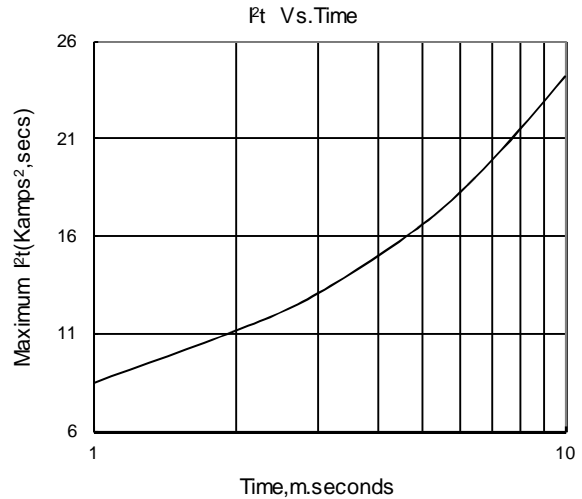

Fig.8

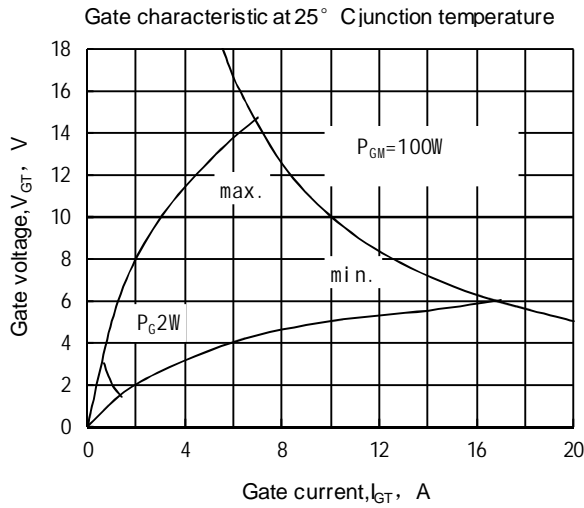

Fig.9

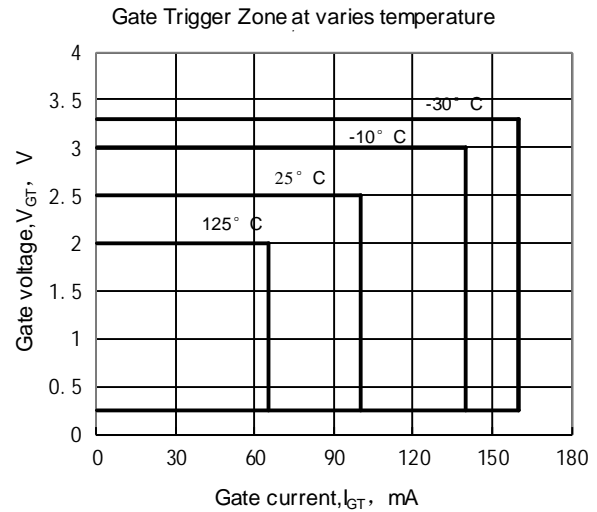
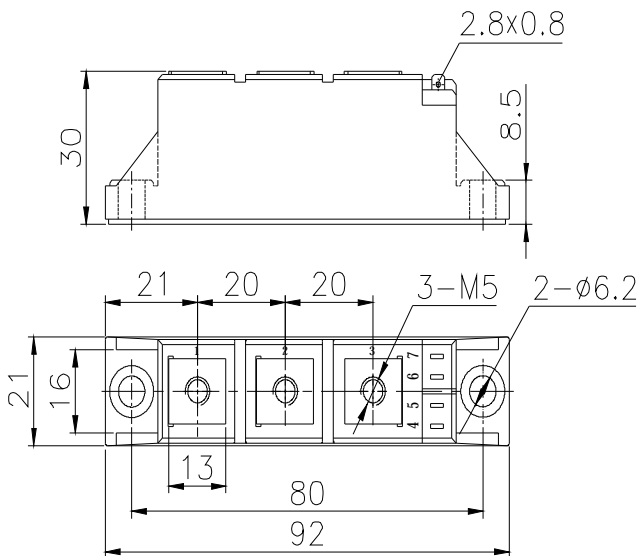

Fig.10

Outline:



223F3B

