



### Features:

- Isolated mounting base 3000V~
- Pressure contact technology with Increased power cycling capability
- Space and weight saving

### Typical Applications

- AC/DC Motor drives
- Various rectifiers
- DC supply for PWM inverter

$V_{DSM}, V_{RSM}$	$V_{DRM}, V_{RRM}$	Type & Outline
900V	800V	MTx70-08-223F3
1100V	1000V	MTx70-10-223F3
1300V	1200V	MTx70-12-223F3
1500V	1400V	MTx70-14-223F3
1700V	1600V	MTx70-16-223F3
1900V	1800V	MTx70-18-223F3

SYMBOL	CHARACTERISTIC	TEST CONDITIONS	$T_j(^{\circ}C)$	VALUE			UNIT
				Min	Type	Max	
$I_{T(AV)}$	Mean on-state current	180° half sine wave 50Hz Single side cooled, $T_c=85^{\circ}C$	125			70	A
$I_{T(RMS)}$	RMS on-state current		125			110	A
$I_{DRM}$ $I_{RRM}$	Repetitive peak current	at $V_{DRM}$ at $V_{RRM}$	125			10	mA
$I_{TSM}$	Surge on-state current	10ms half sine wave	125			1.50	KA
$I^2t$	$I^2T$ for fusing coordination	$V_R=60\%V_{RRM}$				11.3	$A^2s \times 10^3$
$V_{TO}$	Threshold voltage		125			0.80	V
$r_T$	On-state slop resistance					2.64	m $\Omega$
$V_{TM}$	Peak on-state voltage	$I_{TM}=210A$	25			1.48	V
$dv/dt$	Critical rate of rise of off-state voltage	$V_{DM}=67\%V_{DRM}$	125			1000	V/ $\mu s$
$di/dt$	Critical rate of rise of on-state current	Gate source 1.5A $t_r \leq 0.5\mu s$ Repetitive	125			200	A/ $\mu s$
$I_{GT}$	Gate trigger current	$V_A=12V, I_A=1A$	25	30		100	mA
$V_{GT}$	Gate trigger voltage			0.8		2.5	V
$I_H$	Holding current			20		120	mA
$V_{GD}$	Non-trigger gate voltage	$V_{DM}=67\%V_{DRM}$	125	0.2			V
$R_{th(j-c)}$	Thermal resistance Junction to case	Single side cooled per chip				0.410	$^{\circ}C/W$
$R_{th(c-h)}$	Thermal resistance case to heatsink	Single side cooled per chip				0.2	$^{\circ}C/W$
$V_{iso}$	Isolation voltage	50Hz, R.M.S, $t=1min, I_{iso}: 1mA(MAX)$		3000			V
$F_m$	Thermal connection torque(M5)				4.0		N·m
	Mounting torque(M6)				6.0		N·m
$T_{stg}$	Stored temperature			-40		140	$^{\circ}C$
$W_t$	Weight				160		g
Outline	223F3						

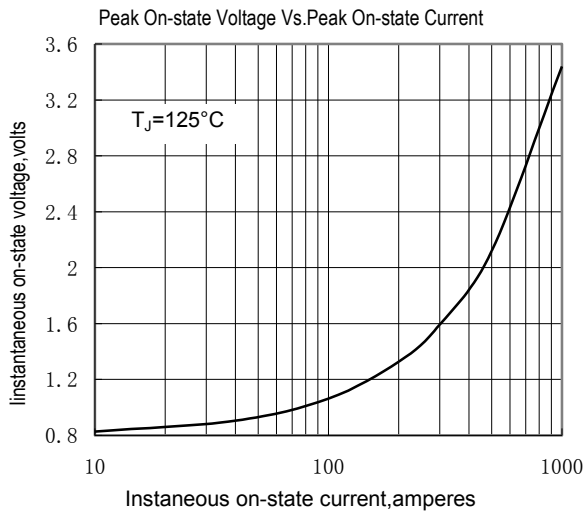

Fig.1

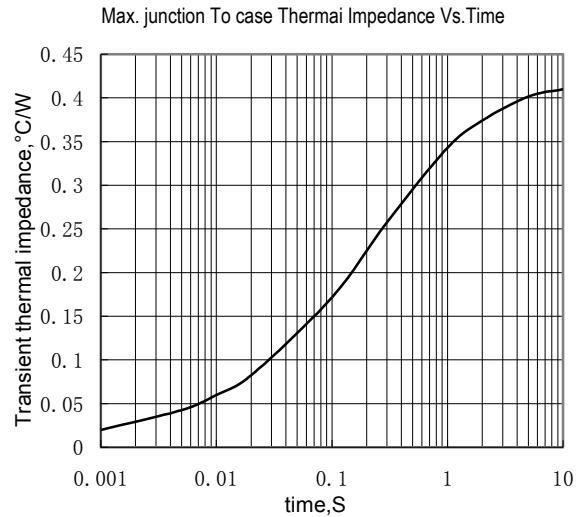

Fig.2

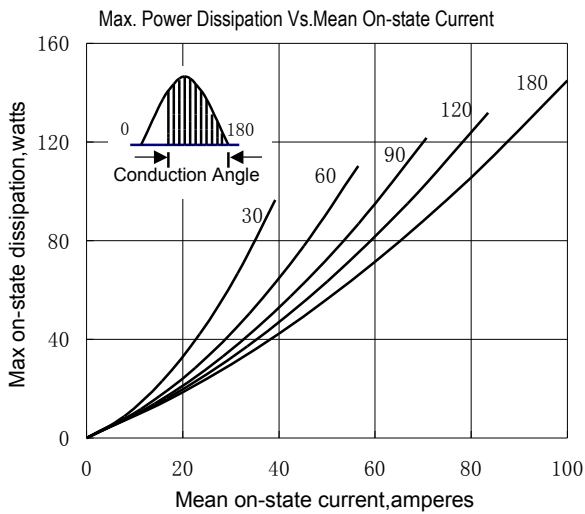

Fig.3

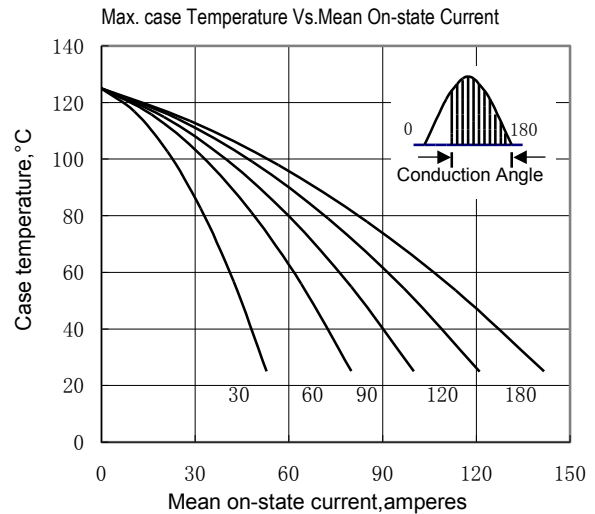

Fig.4

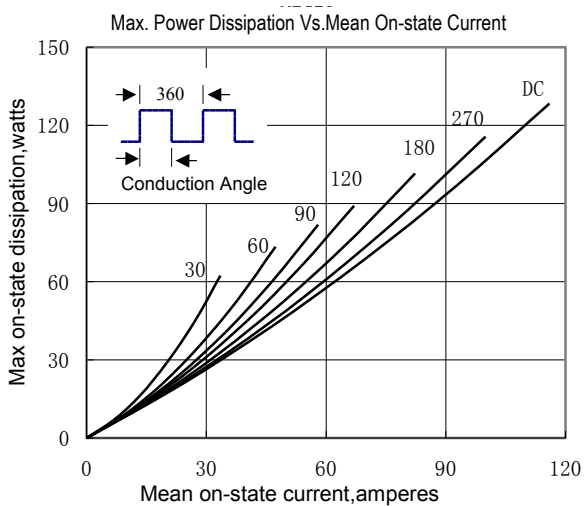

Fig.5

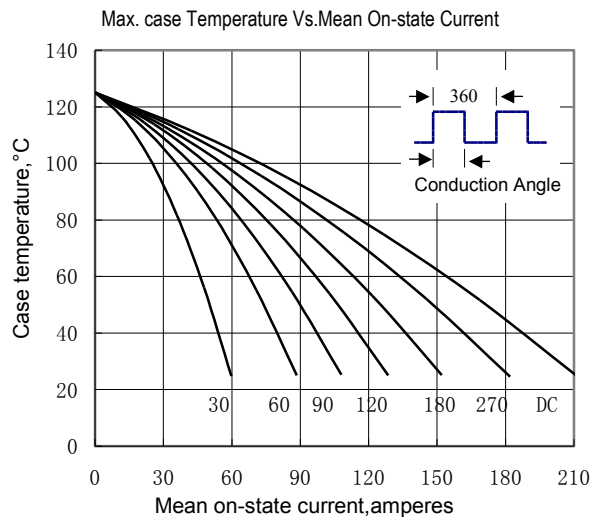

Fig.6

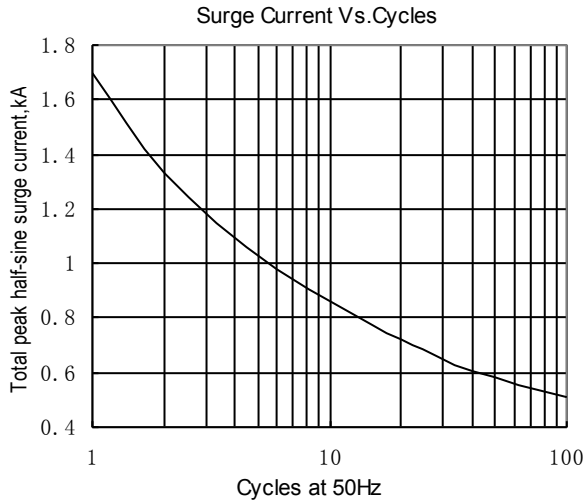

Fig.7

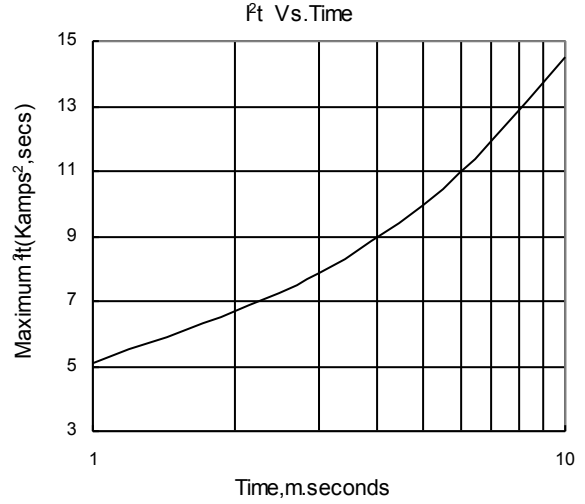

Fig.8

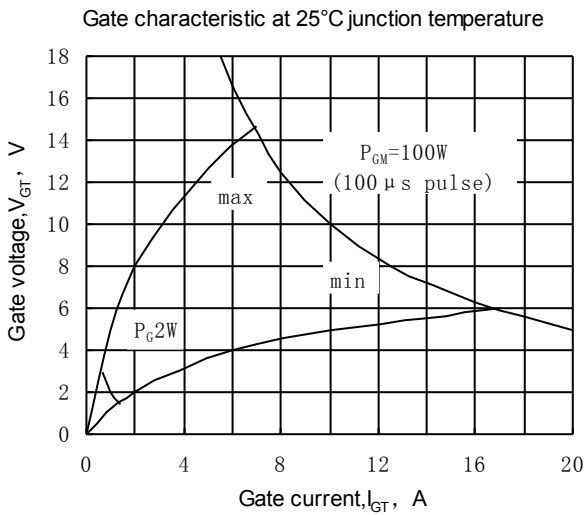

Fig.9

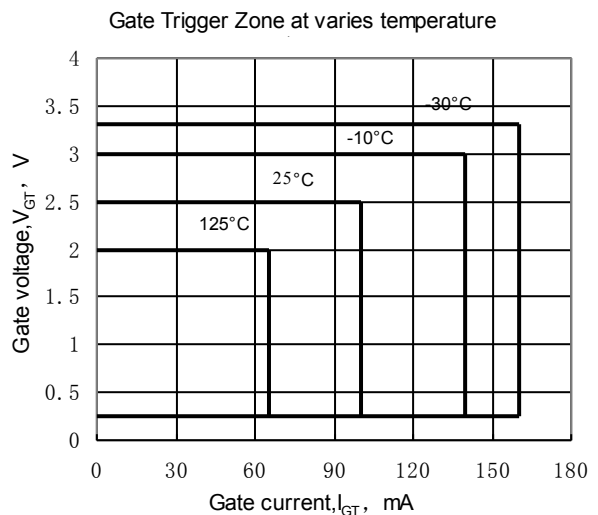
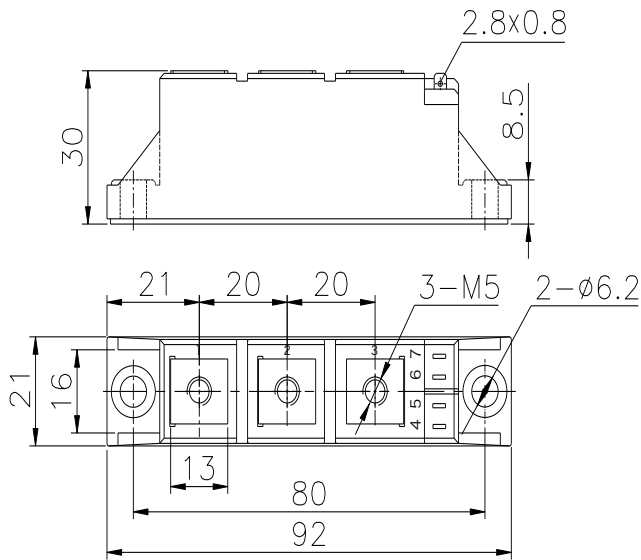

Fig.10

**Outline:**



**223F3**

